

This article was downloaded by:

On: 24 January 2011

Access details: *Access Details: Free Access*

Publisher *Taylor & Francis*

Informa Ltd Registered in England and Wales Registered Number: 1072954 Registered office: Mortimer House, 37-41 Mortimer Street, London W1T 3JH, UK



Journal of Macromolecular Science, Part A

Publication details, including instructions for authors and subscription information:

<http://www.informaworld.com/smpp/title~content=t713597274>

A Nonlinear Method for the Estimation of Reactivity Ratios in Copolymerization Processes

Cornel Hagiopol^a; Octavian Frangu^a; Lucian Dumitru^a

^a ICECHIM-CCMP Spl., Bucharest, Romania

To cite this Article Hagiopol, Cornel , Frangu, Octavian and Dumitru, Lucian(1989) 'A Nonlinear Method for the Estimation of Reactivity Ratios in Copolymerization Processes', *Journal of Macromolecular Science, Part A*, 26: 10, 1363 – 1379

To link to this Article: DOI: 10.1080/00222338908052056

URL: <http://dx.doi.org/10.1080/00222338908052056>

PLEASE SCROLL DOWN FOR ARTICLE

Full terms and conditions of use: <http://www.informaworld.com/terms-and-conditions-of-access.pdf>

This article may be used for research, teaching and private study purposes. Any substantial or systematic reproduction, re-distribution, re-selling, loan or sub-licensing, systematic supply or distribution in any form to anyone is expressly forbidden.

The publisher does not give any warranty express or implied or make any representation that the contents will be complete or accurate or up to date. The accuracy of any instructions, formulae and drug doses should be independently verified with primary sources. The publisher shall not be liable for any loss, actions, claims, proceedings, demand or costs or damages whatsoever or howsoever caused arising directly or indirectly in connection with or arising out of the use of this material.

A NONLINEAR METHOD FOR THE ESTIMATION OF REACTIVITY RATIOS IN COPOLYMERIZATION PROCESSES

CORNEL HAGIOPOL,* OCTAVIAN FRANGU, and LUCIAN DUMITRU

ICECHIM—CCMP

Spl. Independentei 202

Bucharest 79611, Romania

ABSTRACT

A nonlinear method (OPT) for the estimation of the reactivity ratios in copolymerization processes is proposed. This method makes use of all experimental data (the conversion values included) and may also use the composition equations determined according to either the simple terminal kinetic model or the penultimate model. It can be extended to ternary copolymerization processes, too. Application of OPT to ternary copolymerization data lead to reactivity ratios that are different from those obtained for the respective binary copolymerizations. The former give a better fit to the experimental results than the latter.

INTRODUCTION

It is quite important to know the values of the reactivity ratios in copolymerization processes, for they are helpful for the calculation of copolymer composition at various conversions [1, 2] in the choice of azeotropic compositions [3], as well as in carrying out semicontinuous copolymerization reactions [4].

The kinetic pictures of the propagation steps suggested by Mayo and Lewis for binary copolymerization and by Alfrey and Goldfinger for ternary copolymerization are, in fact, simplified, and the resulting equations use *apparent* reactivity ratios only (r_i and r_{ih} , respectively).

Binary copolymerization, which is the most conveniently studied copolymerization type, represents the starting point of any attempt to analyze a copolymerization process. The reactivity ratios determined for binary copolymerization are also used to characterize multicomponent copolymerization processes. That is the reason why the Mayo-Lewis equation has been so thoroughly examined both in its differential and integral forms. This relatively simple equation led to various linearization methods for the computation of the r_i constants [5]. A critical approach to the Fineman-Ross (FR) and Yezrielev-Brokhina-Roskin methods was presented by Kelen and Tüdös [6], who also proposed an improved linear method (KT) for the estimation of r_1 and r_2 and of the confidence limits [7].

In spite of increased activity for developing new linear methods [8], the KT procedure still represents a landmark in this field. It has even brought about the recalculation of a great number of monomer reactivity ratios (MRR) [9].

The complexity of the process under discussion has led to nonlinear techniques for the estimation of the MRR [10, 11], which require a greater amount of calculation but are much more accurate. The resulting approximate 95% confidence regions point out the superiority of the Tidwell-Mortimer method (TM).

Improved computation techniques have reduced the benefits of the much simpler linear methods and have made practical the tackling of nonlinear methods which require much more computation but lead to more accurate interpretations of the experimental data.

If the MRR derived for binary copolymerization are used for multicomponent copolymerization, the kinetic approach is even more simplified. Still, it is necessary to find some method to permit the calculation of the r_i for binary copolymerizations, and the r_{ih} for multicomponent copolymerizations, directly from the experimental data.

Suggestions have been made for taking into account the errors in all the variables [12, 13]. Besides, a direct search method [14, 15] has been put forward for checking the penultimate model [16], but special attention should be paid to the conversion data which may influence the calculation of the copolymer composition (m_i) when the monomer composition (M_i) is far from the azeotropy point.

The present paper proposes a method (OPT) which helps to find the optimum values of the apparent MRR by minimizing a certain function starting from the experimental data for binary and ternary copolymerizations, respectively. The conversion value recorded in each experiment is also taken into account. This technique makes use of a Simplex algorithm which pro-

vides a step-by-step optimization, selectively taking into account the results of the previous steps. The modified algorithm of Nelder and Mead [17] has been developed to improve the convergence rate; this has also been used with excellent results in other research fields [18, 19].

RESULTS AND DISCUSSIONS

Figure 1 shows the flow chart for the program used in the estimation of the apparent MRR for copolymerization.

The objective function (F) to be minimized is

$$F = \sqrt{\frac{\sum_{i=1}^n \sum_{j=1}^p (m_i^{j(e)} - m_i^{j(c)})^2}{n(p - n + 1)}}, \quad (1)$$

where n is the number of monomers, p is the number of experiments, $m_i^{j(e)}$ is the copolymer composition (experimentally determined) for Monomer i ($i = 1, n$) found in the j th experiment ($j = 1, p$), and $m_i^{j(c)}$ is the mole fraction of Monomer i in the copolymer, calculated by the Mayo-Lewis or Alfrey-Goldfinger equation, from the monomer composition (M_i). The calculation may also use the equation for the penultimate model [16].

Convergence is reached when the standard deviation (E) is smaller than a certain rather small quantity (ϵ). The scatter, characterized by the parameter E , refers to the last steps selected, and the limiting standard deviation is chosen to be $\epsilon = 0.1$. The convergence rate depends on the reflexion (α), contraction (β), and expansion (γ) coefficients proposed by different authors who used the same kind of algorithm [18] to optimize other functions.

The flow chart in Fig. 1 helped to develop a set of programs for the estimation of the MRR for ternary copolymerization (OPT-6) or binary copolymerization (from the equation defined according to the simple terminal model (OPT-2) or the penultimate model (OPT-4)). For such cases, the conversion is set at a low level (0.1%) and the F function is labeled as F_{Co} .

The estimation of the MRR through the SCCC subroutine was performed with the OPT-2C, OPT-4C, and OPT-6C programs, respectively. The SCCC subroutine integrates the differential equation for the $m_i^{j(c)}$ calculation at the conversion noted for the j th experiment. Under such circumstances the F function is calculated for the conversion found for each experiment (F_c).

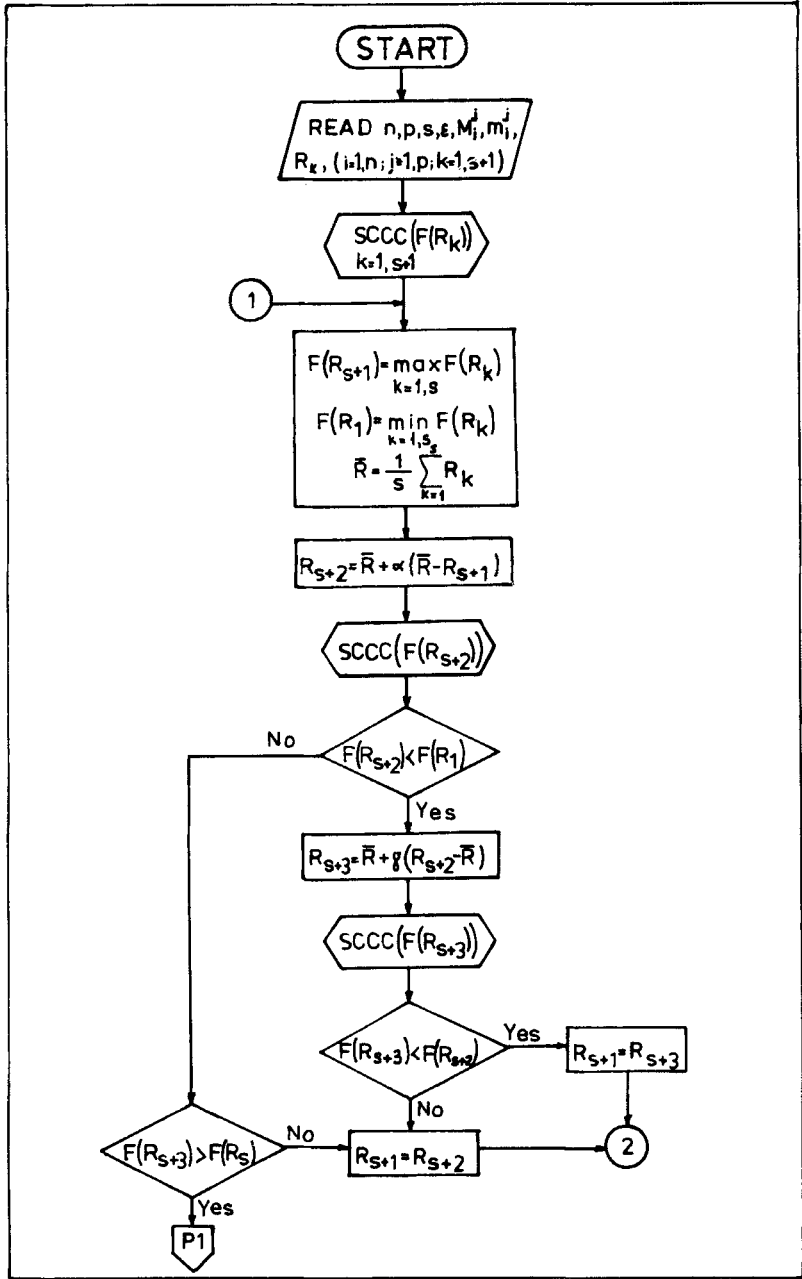
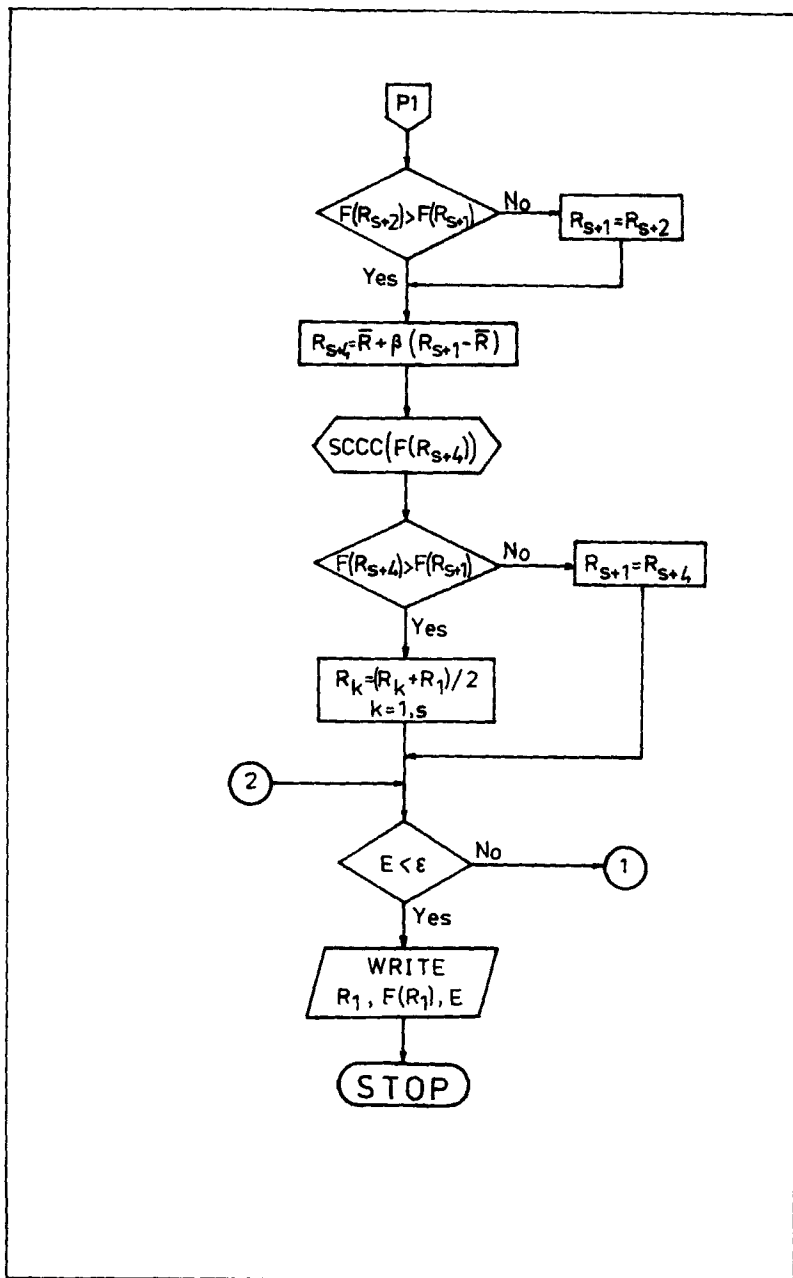

FIG. 1. Flow chart for the program (OPT) used for the estimation of apparent reactivity ratios of monomers in copolymerization processes.



To verify this method, data available in the literature for different systems have been used. The experimental sets were selected with two criteria: the choice of the most comprehensive set of experiments and covering the widest range of the M_i/M_h ratios in the initial comonomer mixture. The conversion values should be available as well.

For these reasons, acrylonitrile (AN- M_1)/styrene (St- M_2) [20], acrylonitrile (M_1)/*N*-vinyl caprolactam (NVC- M_2) [21], and 2,4,6-tribromophenyl methacrylate (TBPM- M_1)/acrylonitrile (M_2) [22] copolymerizations were chosen. The monomer (M_i^j) and copolymer ($m_i^{j(e)}$) compositions as well as the conversion values are used as input data.

The apparent MRR were estimated by the FR, KT, and TM methods. The technique (OPT) put forward in this paper allowed the estimation of other values of r_1 and r_2 (for the simple terminal model, Program OPT-2) or r_{11} , r_{21} , r_{22} , and r_{12} (for the penultimate model, Program OPT-4) for which a minimum value is calculated for the F function. Table 1 shows the MRR values estimated by the above-mentioned techniques and the corresponding values of the F function for AN/NVC copolymerization.

The TM and OPT-2 methods are the most appropriate. They lead to practically identical results:

$$(F_{co})_{OPT-2} = (F_{co})_{TM} < (F_{co})_{KT} < (F_{co})_{FR}.$$

The effect of taking the conversion values into account can be noted,

$$F_{co} \neq F_c,$$

for the same technique of processing data and for

$$(F_c)_{OPT-2C} < (F_c)_{OPT-2}$$

and

$$(F_c)_{OPT-4C} < (F_c)_{OPT-4}.$$

The size of the approximate 95% confidence region shown in Fig. 2 for AN/NVC (the region is bounded by contours corresponding to those of the probability function [10]) bears this for the F function.

The approximate 95% confidence regions, for the calculation of which the SCCC was used (Fig. 2), points out the benefits of taking into account the conversion data. Analysis of the St/AN and TBPM/AN copolymerizations (Tables 2 and 3, Fig. 3) leads to similar conclusions.

TABLE 1. Reactivity Ratios for AN (M_1)/NVC (M_2) Copolymerization Estimated by Various Methods

MRR	Estimation method							
	FR	KT	TM	OPT-2	OPT-2C	OPT-4	OPT-4C	
r_{11}	0.275	0.194	0.215	0.215	0.205	0.276	0.339	
r_{22}	0.125	0.035	0.027	0.027	0.024	4.3×10^{-5}	4.9×10^{-5}	
r_{21}	0.275 ^a	0.194 ^a	0.215 ^a	0.215 ^a	0.205 ^a	0.187	0.154	
r_{12}	0.125 ^a	0.035 ^a	0.027 ^a	0.027 ^a	0.024 ^a	0.055	0.060	
$F_{CO} \times 10^3$	87.7	36.2	33.2	33.2	—	26.5	—	
$F_c \times 10^3$	94.1	35.9	32.1	32.1	31.7	21.4	19.2	

^a $r_{21} = r_{11}$ and $r_{12} = r_{22}$ (for the simple terminal model).

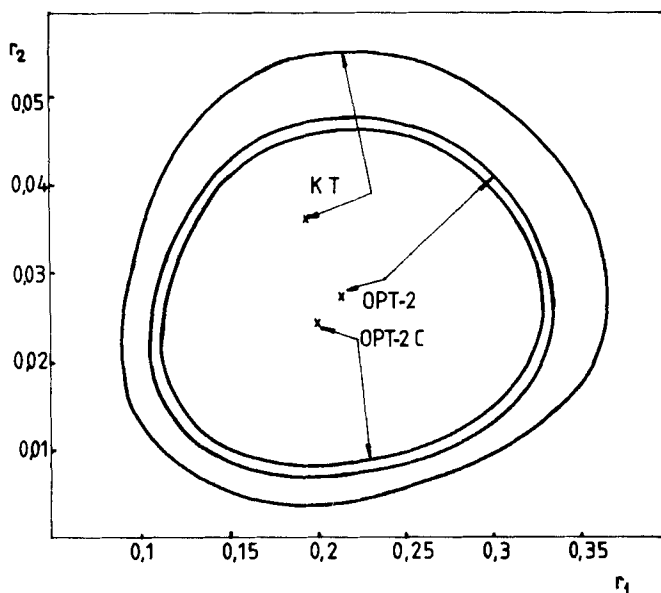

FIG. 2. The approximate 95% confidence regions, calculated by means of the conversion data, for the reactivity ratios determined by the KT, OPT-2, and OPT-2C methods for AN (M_1)/NVC (M_2) copolymerization.

The OPT method proposed in the present paper proved to be a multipurpose one: it takes into account many parameters, sets the $m_i^{j(c)}$ for a large number of experiments, and selects the optimum MRR values. Thus, it can use the composition equation determined according to the penultimate model for binary copolymerization (OPT-4 and OPT-4C programs, respectively). Use of the penultimate model and of the conversion in the calculation gives values with a better fit to the experimental ones (Tables 1-3 and Fig. 4).

These features of the OPT method make it possible to calculate the apparent MRR (r_{ih}) of the monomers involved in a multicomponent copolymerization. In the following, the results of calculations from the experimental data for the methacrylonitrile (MAN- M_1)/St (M_2)/ α -methylstyrene (MSt- M_3) [23] ternary copolymerization are presented.

The above-mentioned ternary system was chosen because it was the one that Rudin and coworkers adopted to verify other optimization methods. Table 4 shows the MRR calculated for the respective binary copolymerizations

TABLE 2. Reactivity Ratios for St (M_1)/AN (M_2) Copolymerization Estimated by Various Methods

MRR	Estimation method						
	FR	KT	TM	OPT-2	OPT-2C	OPT-4	OPT-4C
r_{11}	0.295	0.371	0.370	0.370	0.348	0.332	0.297
r_{22}	0.064	0.068	0.067	0.067	0.048	0.055	0.023
r_{21}	0.295 ^a	0.371 ^a	0.370 ^a	0.370 ^a	0.348 ^a	0.448	0.492
r_{12}	0.064 ^a	0.068 ^a	0.067 ^a	0.067 ^a	0.048 ^a	0.082	0.093
$F_{c0} \times 10^3$	17.6	8.3	8.2	8.2	—	7.4	—
$F_c \times 10^3$	28.1	27.7	26.7	26.7	15.6	24.3	8.9

^a $r_{21} = r_{11}$ and $r_{12} = r_{22}$ (for the simple terminal model).

TABLE 3. Reactivity Ratios for TBPM (M_1)/AN (M_2) Copolymerization Estimated by Various Methods

MRR	Estimation method							
	FR	KT	TM	OPT-2	OPT-2C	OPT-4	OPT-4C	
r_{11}	0.985	0.982	0.985	0.985	0.982	0.936	0.955	
r_{22}	0.203	0.200	0.200	0.200	0.186	0.242	0.211	
r_{21}	0.985 ^a	0.982 ^a	0.985 ^a	0.985 ^a	0.982 ^a	0.960	0.986	
r_{12}	0.203 ^a	0.200 ^a	0.200 ^a	0.200 ^a	0.186 ^a	0.158	0.161	
$F_{co} \times 10^3$	4.21	4.08	4.06	4.06	—	2.53	—	
$F_c \times 10^3$	8.45	7.21	7.25	7.25	3.41	6.94	1.88	

^a $r_{21} = r_{11}$ and $r_{12} = r_{22}$ (for the simple terminal model).

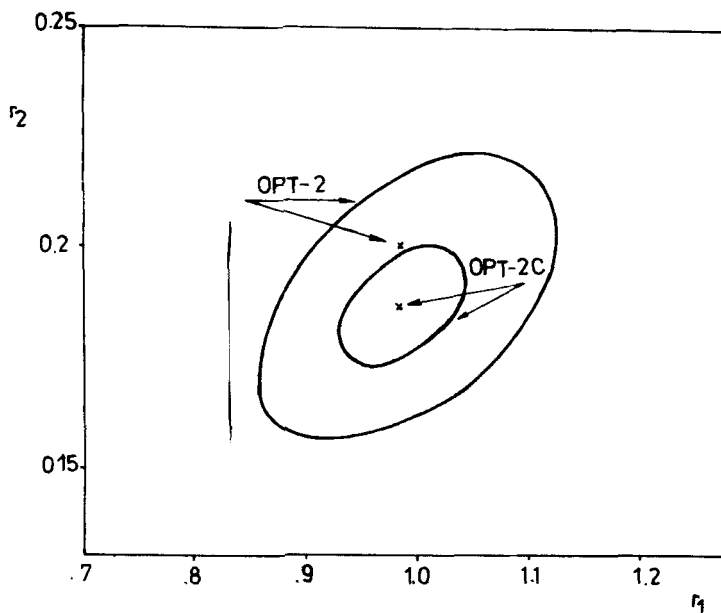

FIG. 3. The approximate 95% confidence regions for the reactivity ratios determined by the OPT-2 and OPT-2C methods for TBPM (M_1)/AN (M_2) copolymerization.

[23-25] together with those proposed by Rudin and coworkers for their M-1, M-2, and M-3 optimization models. The r_{ih} values determined with the OPT-6 program are also listed.

The MRR sets shown in Table 4 are obviously different, particularly the values of r_{13} and r_{23} . With F as the criterion for the agreement between the calculated ($m_i^{j(c)}$) and the experimental ($m_i^{j(e)}$) values, the superiority of all the optimization techniques that make use of ternary copolymerization data is apparent. Model M-2 is Rudin's best optimization, but even this is significantly less effective than the OPT-6 program of this paper.

The similarity between the $m_i^{j(e)}$ and the $m_i^{j(c)}$ calculated with the OPT-6 technique is shown especially by the approximate 95% confidence regions in Figs. 5, 6, and 7.

These findings reveal significant differences between the sets of apparent MRR calculated from the binary copolymerizations and those obtained upon a proper calculation from the ternary copolymerization experimental data.

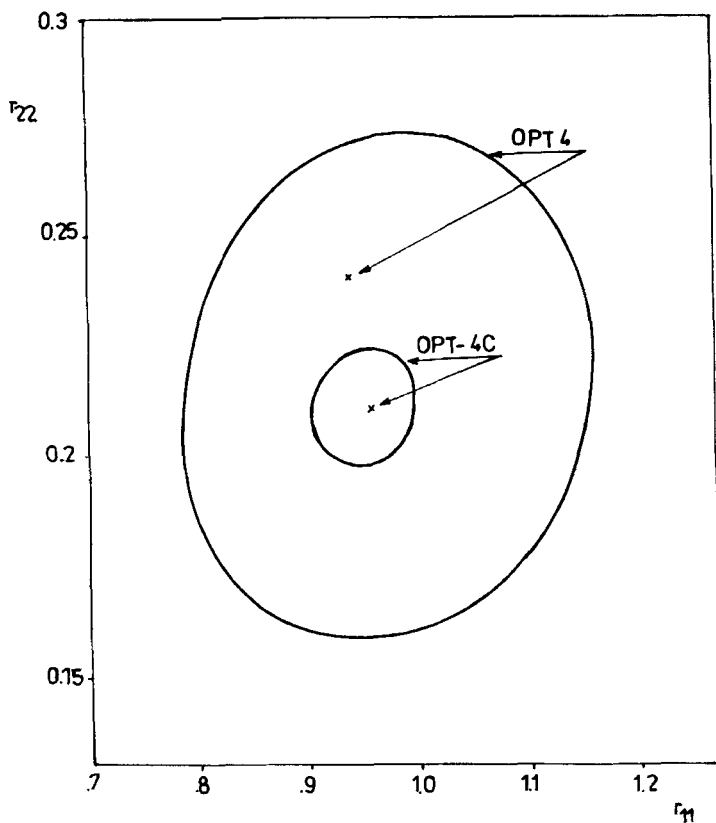

FIG. 4. The approximate 95% confidence regions for the reactivity ratios determined by the OPT-4 ($r_{21} = 0.960$, $r_{12} = 0.158$) and OPT-4C ($r_{21} = 0.986$, $r_{12} = 0.161$) methods for TBPM (M_1)/AN (M_2) copolymerization.

The results in the present paper indicate the necessity to analyze the binary and the multicomponent copolymerization processes differently. The information obtained from binary copolymerizations (r_1 and r_2) represent but a preliminary stage in the characterization of the monomer reactivity involved in a multicomponent copolymerization, a much more complex system. Moreover, the penultimate model must be taken into account in any kind of copolymerization process.

TABLE 4. Ternary Copolymerization of the Methacrylonitrile (M_1)/Styrene (M_2)/ α -Methylstyrene (M_3) Reactivity Ratios Calculated by Different Methods

Method	r_{12}	r_{21}	r_{13}	r_{31}	r_{23}	r_{32}	$F_{CO} \times 10^2$
Binary copolymerization	0.44	0.37	0.38	0.53	1.12	0.63	2.95
Rudin M-1	0.46	0.18	1.15	0.24	0.17	0.34	2.51
Rudin M-2	0.53	0.52	1.13	0.23	0.40	0.85	1.82
Rudin M-3	0.55	0.45	1.49	0.23	0.33	0.57	1.87
OPT-6	0.4915	0.4689	0.7912	0.2658	0.5615	0.7645	1.39

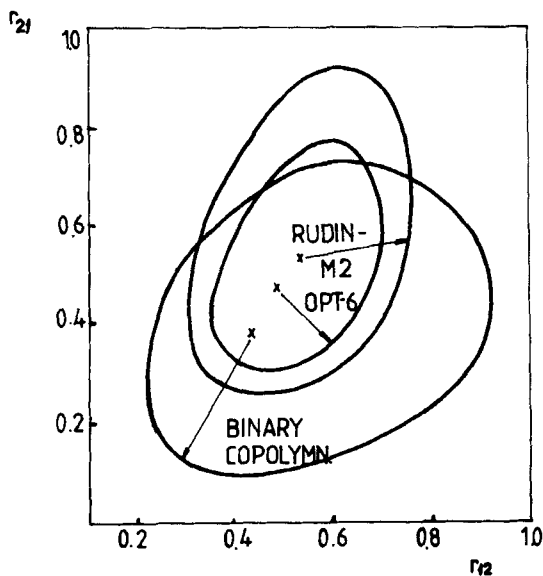

FIG. 5. The approximate 95% confidence regions for the reactivity ratios r_{12} and r_{21} determined by the TM (binary copolymerization: $r_{13} = 0.38$, $r_{31} = 0.53$, $r_{23} = 1.12$, $r_{32} = 0.63$), Rudin's model [23] M-2 ($r_{13} = 1.13$, $r_{31} = 0.23$, $r_{23} = 0.40$, $r_{32} = 0.85$), and OPT-6 ($r_{13} = 0.7912$, $r_{31} = 0.2658$, $r_{23} = 0.5615$, $r_{32} = 0.7645$) methods for MAN (M_1)/ST (M_2)/MSt (M_3) ternary copolymerization.

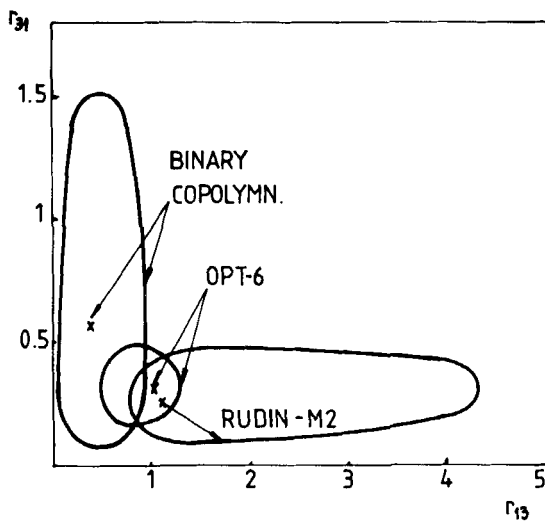

FIG. 6. The approximate 95% confidence regions for the reactivity ratios r_{13} and r_{31} determined by the TM (binary copolymerization: $r_{12} = 0.44$, $r_{21} = 0.37$, $r_{23} = 1.12$, $r_{32} = 0.63$), Rudin's model [23] M-2 ($r_{12} = 0.53$, $r_{21} = 0.52$, $r_{23} = 0.40$, $r_{32} = 0.85$), and OPT-6 ($r_{12} = 0.4915$, $r_{21} = 0.4689$, $r_{23} = 0.5615$, $r_{32} = 0.7645$) methods for MAN (M_1)/St (M_2)/MSt (M_3) ternary copolymerization.

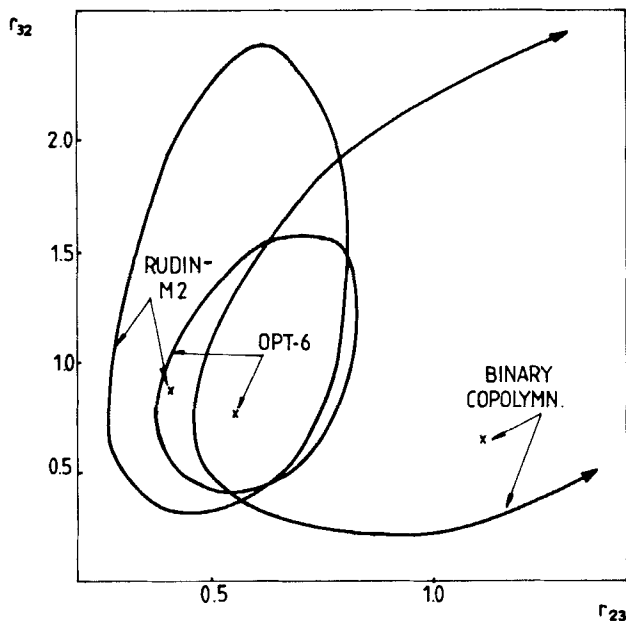

FIG. 7. The approximate 95% confidence regions for the reactivity ratios r_{23} and r_{32} determined by the TM (binary copolymerization: $r_{12} = 0.44$, $r_{21} = 0.37$, $r_{13} = 0.38$, $r_{31} = 0.53$), Rudin's model [23] M-2 ($r_{12} = 0.53$, $r_{21} = 0.52$, $r_{13} = 1.13$, $r_{31} = 0.23$), and OPT-6 ($r_{12} = 0.4915$, $r_{21} = 0.4689$, $r_{13} = 0.7912$, $r_{31} = 0.2658$) methods for MAN (M_1)/St (M_2)/MSt (M_3) ternary copolymerization.

CONCLUSION

The OPT technique makes use of all the composition and conversion data provided by the copolymerization experiments. It allows the estimation of optimum values for the apparent monomer reactivity ratios in binary copolymerizations and in multicomponent copolymerization processes as well.

REFERENCES

- [1] K. F. O'Driscoll, L. T. Kale, L. H. Garcia Rubio, and P. M. Reilly, *J. Polym. Sci., Polym. Chem. Ed.*, **22**, 2777 (1984).

- [2] Z. Janovic, K. Saric, and O. Vogl, *J. Macromol. Sci.—Chem.*, **A22**, 85 (1985).
- [3] L. Rios and J. Guillot, *Ibid.*, **A12**, 1151 (1978).
- [4] A. Matejcek and J. Horky, *Angew. Makromol. Chem.*, **140**, 73 (1986).
- [5] R. M. Joshi, *J. Macromol. Sci.—Chem.*, **A7**, 1231 (1973).
- [6] T. Kelen and F. Tüdös, *Ibid.*, **A9**, 1 (1975).
- [7] T. Kelen, F. Tüdös, and B. Turcsonyi, *Polym. Bull.*, **2**, 71 (1981).
- [8] D. G. Watts, H. N. Linssen, and J. Schrijver, *J. Polym. Sci., Polym. Chem. Ed.*, **18**, 1285 (1980).
- [9] D. Braun, W. Czerwinski, G. Disselhoff, F. Tüdös, T. Kelen, and B. Turcsonyi, *Angew. Makromol. Chem.*, **125**, 161 (1984).
- [10] D. W. Behnken, *J. Polym. Sci.*, **A2**, 645 (1964).
- [11] P. W. Tidwell and G. A. Mortimer, *Ibid.*, **A3**, 369 (1965).
- [12] H. Patino-Leal, P. M. Reilly, and K. F. O'Driscoll, *J. Polym. Sci., Polym. Lett. Ed.*, **18**, 219 (1980).
- [13] T. A. Duever, K. F. O'Driscoll, and P. M. Reilly, *J. Polym. Sci., Polym. Chem. Ed.*, **21**, 2003 (1983).
- [14] R. E. Cais, R. G. Farmer, D. J. T. Hill, and J. H. O'Donnell, *Macromolecules*, **12**, 835 (1979).
- [15] D. Braun and W. Czerwinski, *Makromol. Chem.*, **184**, 1071 (1983).
- [16] E. Merz, T. Alfrey, and G. Goldfinger, *J. Polym. Sci.*, **1**, 75 (1946).
- [17] J. A. Nelder and R. Mead, *Comput. J.*, **7**, 308 (1965).
- [18] C. Bindschaedler and R. Gurny, *Pharm. Acta Helv.*, **57**, 251 (1982).
- [19] D. E. Long, *Anal. Chim. Acta*, **46**, 193 (1969).
- [20] B. R. Thompson and R. H. Raines, *J. Polym. Sci.*, **41**, 265 (1959).
- [21] N. Cobianu, C. Boghina, B. Marculescu, and I. Amalinei, *Rev. Roum. Chim.*, **18**, 305 (1973).
- [22] Z. Janovic, K. Saric, and O. Vogl, *Croat. Chim. Acta*, **59**, 413 (1986).
- [23] A. Rudin, W. R. Ableson, S. S. M. Chiang, and G. W. Bennett, *J. Macromol. Sci.—Chem.*, **A7**, 1203 (1973).
- [24] K. Johnston and A. Rudin, *Macromolecules*, **4**(6), 661 (1971).
- [25] A. Rudin, S. S. M. Chiang, K. Johnston, and P. D. Paulin, *Can. J. Chem.*, **50**, 1757 (1972).

Received June 15, 1988

Revision received September 19, 1988